

Information only, not for manufacture

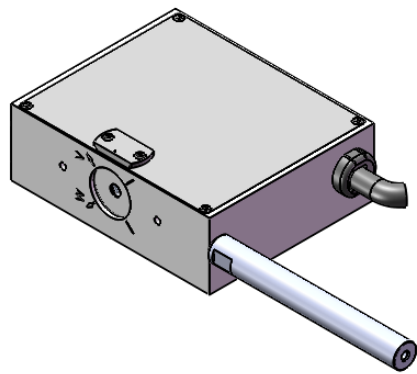

Scale 1:2

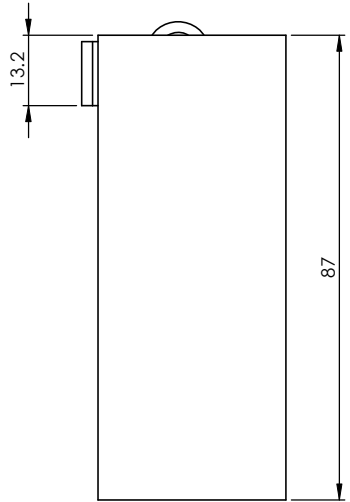
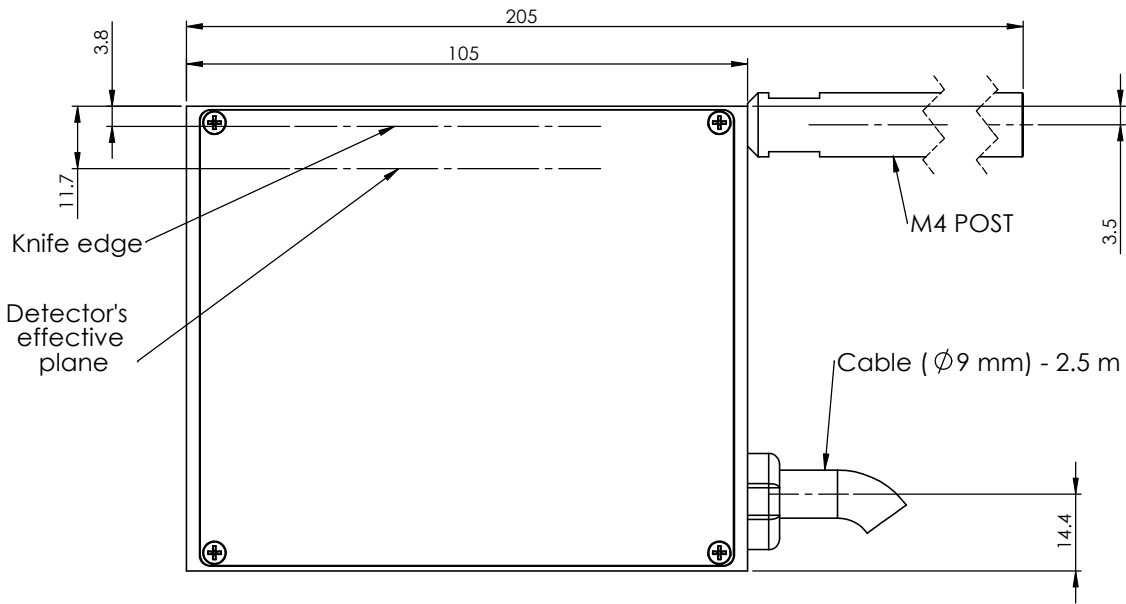
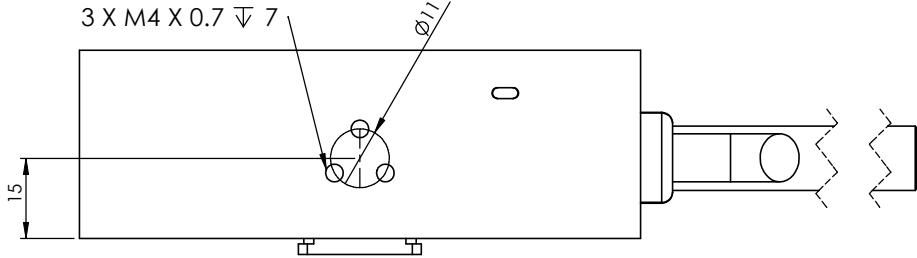
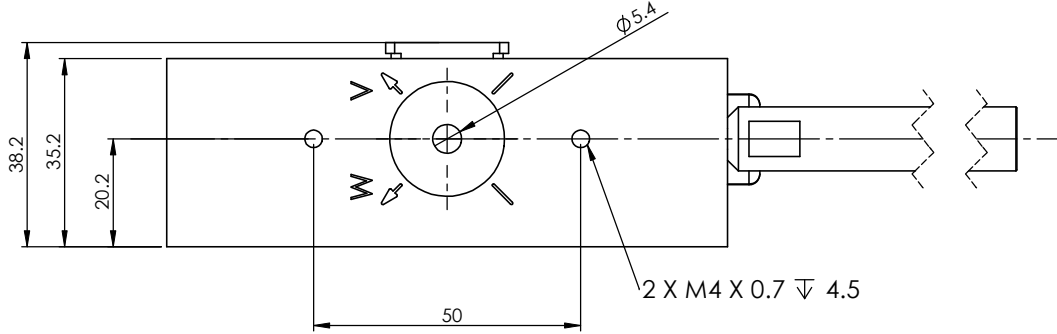

Tolerances:
Unless otherwise
specified:

Linear: ± 0.1
Angular: ± 0.1

Do not scale drawing

DIMENSIONS IN MILLIMETERS (mm) scale 1:1



TITLE:
BA3 - UV

DWG NO.
BAN_C_02

	NAME	SIGNATURE	DATE
DRAWN	Yair		21.6.2012
CHKD	Oren		21.6.2012
APPVD	Judith		21.6.2012