

# BeamOn CCD Beam Profiler

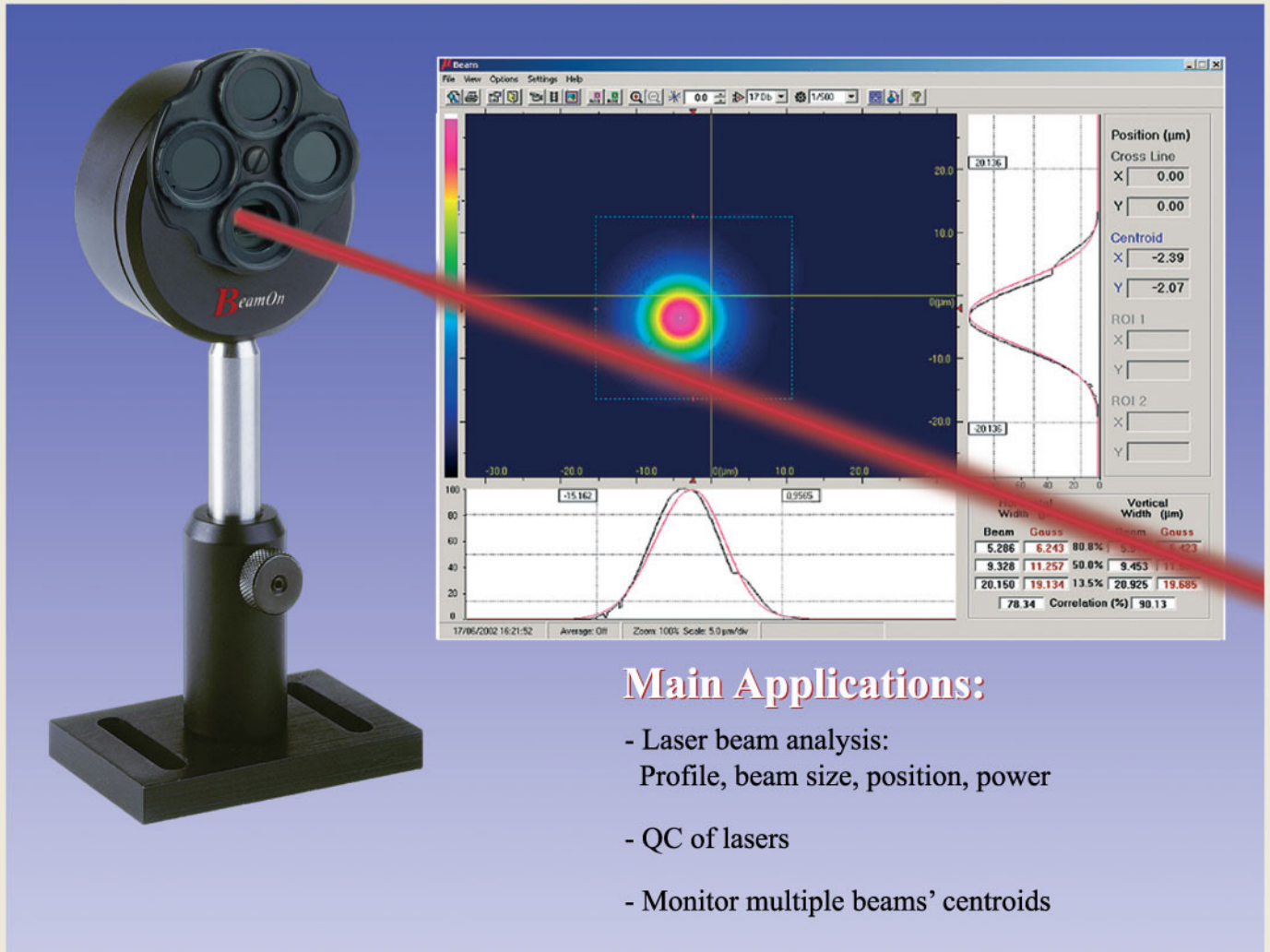

The image shows the BeamOn CCD Beam Profiler hardware on the left, which is a black, cylindrical device mounted on a silver stand. A red laser beam is shown entering the device. On the right, a screenshot of the software interface is displayed. The interface features a central 2D color plot of a laser beam profile, with a red crosshair indicating the beam's position. Below the 2D plot is a 1D intensity profile graph. To the right of the 2D plot, there are fields for 'Position (µm)' (Cross Line X: 0.00, Y: 0.00) and 'Centroid' (X: -2.39, Y: -2.07). At the bottom right, there is a table with columns for 'Beam', 'Gauss', and 'Vertical Width (µm)'. The table contains three rows of data, with a summary row at the bottom showing a correlation of 90.13%.

**Main Applications:**

- Laser beam analysis:  
Profile, beam size, position, power
- QC of lasers
- Monitor multiple beams' centroids

## Expanding your profiling capabilities

- **Patented technology:** Wide dynamic range enabled by double sampling technology
- **Versatile:** A complete test station, measures both CW and pulsed beams
- **Flexible:** A wide spectral response from deep UV (190nm), VIS and up to 1550nm
- **Portable:** Based on a USB 2.0 attachment for notebooks (no need for external power supply)
- **Easy to use:** user-friendly software, on-line help routine

## Main Software Features

- Real time beam size and gaussian fit
- 2D/3D plots of beam in real time
- Software controlled electronic shutter & gain
- Video with playback, snapshot files
- Data exporting to another computer via RS232 / TCP-IP
- Data logging with detailed statistics
- Control DLL for a costum application
- Automatic Pass/Fail analysis report



**DUMA OPTRONICS LTD.**

1st Hazait St., P.O.Box 3370 Nesher 20306, Israel Tel:972-4-8200577 Fax: 972-4-8204190  
Website:<http://www.duma.co.il> E-mail:[sales@duma.co.il](mailto:sales@duma.co.il)

# System Presentations

BeamOn provides an extensive range of graphical presentations and analysis of laser beam parameters.

## Beam Profiles and Width

Two types of profiles are being displayed;  
**Sum Profiles**-Displays the two orthogonal profiles, one along the vertical axis and one along the horizontal axis. Each profile is composed of a summation of rows and columns at a beam cross-section.

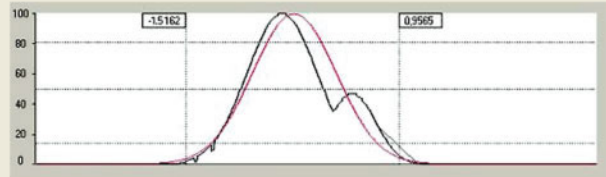

Horizontal Profile

**Line Profiles**-Displays the beam contour along a line parallel to the vertical and horizontal axes. These two orthogonal lines are designated as a cross hair cursor on the image plane and can be moved along the working area.

Horizontal Width ( $\mu\text{m}$ )			Vertical Width ( $\mu\text{m}$ )	
Beam	Gauss		Beam	Gauss
528.6	624.3	80.8%	594.6	642.3
932.8	1125.7	50.0%	945.3	1158.1
2015.0	1913.4	13.5%	2092.5	1968.5
78.34		Correlation (%)	90.13	

Results

Beam widths are digitally displayed for any three user selected clip levels.

A Gaussian fit profile can be overlaid on profiles in real time, while the correlation and fit values are displayed digitally. A Top Hat profile presentation and fit is also available.

## 2D and 3D Intensity Plots

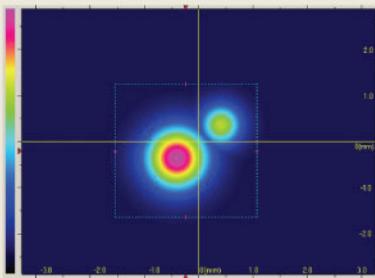

Beam Intensity Pallet

The Projection function provides either a 2D or a 3D plot of the beam intensity profile. A zooming feature enables magnification of the displayed image. It is possible to control the 3D plot wire density. For a weak beam image, even at max shutter and gain settings. Use the beam intensity pallet to optimize color display.

The 2D/3D plots can be rotated along the beam optical axis, as well as be flipped. This feature enables the user to view the image from various angles around the beam.

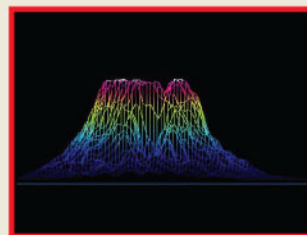

3D Profile - side view

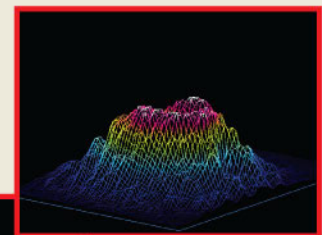

3D Profile - top view

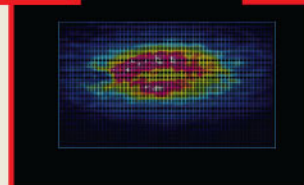

2D Profile

## Power Measurement

The beam power is displayed as a digital readout at the status bar. A power calibration function allows the user enter a "base" power value. In subsequent captured images the summed intensity of all pixels will be proportional to this value.





# System Analysis

BeamOn provides an extensive range of laser beam parameters calculation and analysis.

## Beam Position

The beam centroid is continuously monitored relative to the center of CCD head. Three Regions of Interest (ROI) can be defined by the user, thus enabling the user to monitor up to 3 beams' centroids simultaneously.

## Detailed Statistics

The information in Statistics screen is updated in real time and is useful for analyzing beam characteristics. It lists the information in a table format and shows the actual measurement values, as well as the MIN (minimal measurement), MAX (the maximal measurement), AVER (the averaged value), and STD (the standard deviation) of several parameters which are crucial for beam analysis:

- Centroid (H / V profiles)
- Beam Peak (H / V Profiles)
- Beam width at 3 clip levels (H / V Profiles)
- Correlation to Gaussian profile (H / V Profiles)
- Power (mW)

Statistics	Current	MIN	MAX	AVER	STD
Centroid (µm)					
Horizontal	406.63	406.57	406.64	406.61	0.188
Vertical	17.90	17.88	17.97	17.93	0.026
Beam Peak (µm)					
Horizontal	461.63	434.47	461.63	439.56	10.947
Vertical	24.90	24.90	24.90	24.90	0.002
Horizontal Profile					
Width (µm) (80.0%)	110.48	107.77	110.48	108.87	0.679
Width (µm) (50.0%)	307.42	306.90	307.43	307.21	0.112
Width (µm) (13.5%)	489.11	486.41	489.11	487.74	0.638
Vertical Profile					
Width (µm) (80.0%)	247.17	247.09	247.45	247.24	0.137
Width (µm) (50.0%)	306.73	306.64	306.94	306.74	0.096
Width (µm) (13.5%)	471.92	471.61	472.06	471.92	0.059
Correlation (%)					
Horizontal	85.31	85.25	85.36	85.30	0.039
Vertical	83.81	83.76	83.82	83.80	0.033
Power (mW)	0.696	0.592	0.611	0.602	0.005
Cross Center (µm)					
Horizontal	434.47				
Vertical	66.40				
ROI1 Centroid (µm)					
Horizontal	926.52	926.52	929.10	927.76	0.98
Vertical	1151.77	1150.34	1152.17	1151.54	0.20
ROI1 Beam Peak (µm)					
Horizontal	887.06	814.64	1031.87	911.94	62.58
Vertical	1112.20	1045.80	1261.60	1154.74	70.45
ROI2 Centroid (µm)					
Horizontal	1345.89	1343.88	1345.89	1345.04	0.71
Vertical	526.34	524.17	526.46	525.54	0.64
ROI2 Beam Peak (µm)					
Horizontal	1249.11	1240.06	1466.34	1284.18	75.43
Vertical	581.00	448.20	647.40	516.68	52.01

## Analysis and QA Testing

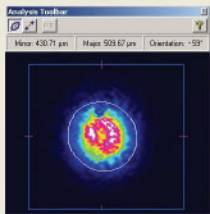

Elipse estimation

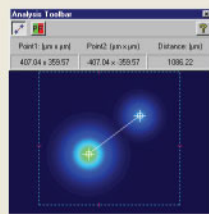

Distance measurement

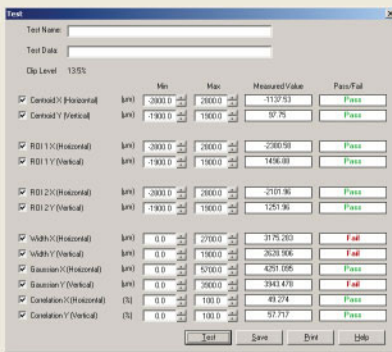

Test

The software enables a best fit to an ellipse as well as direct distance measurement.

The **Elipse function** calculates the best-fit ellipsoid for the examined beam. The major and minor axes of the fit ellipse are calculated as well as the orientation of the major axes of the fit.

The **Distance measurement function** calculates the distance between any two points on the beam image, the points are being selected by the user.

The **Test routine** allows the user to test a laser beam based on user-defined Pass/Fail criteria. The test results are calculated for any one of the beam calculated parameters.

The **Power in the Bucket function** enables accurate power measurement in a specific area defined by the user (circle, ellipse or rectangle) on the beam image.

## More Software Features

- Data logging to a Text file (up to 99 hours)
- Average
- Zooming
- Printing of Text and pictures
- User set threshold levels
- Full on line Help routine
- Live Snapshot files replay for complete analysis of results
- Capture up to 12 still images
- Report function - beam analysis settings & results
- Multiple systems operation (Windows 2000/XP/Vista/7/8)
- Full session recordings for off-line analysis (Mpeg)
- Customer set Pass/Fail criteria
- Tile images in matrix format
- Direct link to Duma's website for support





# Specifications

## CCD Head Drawing:

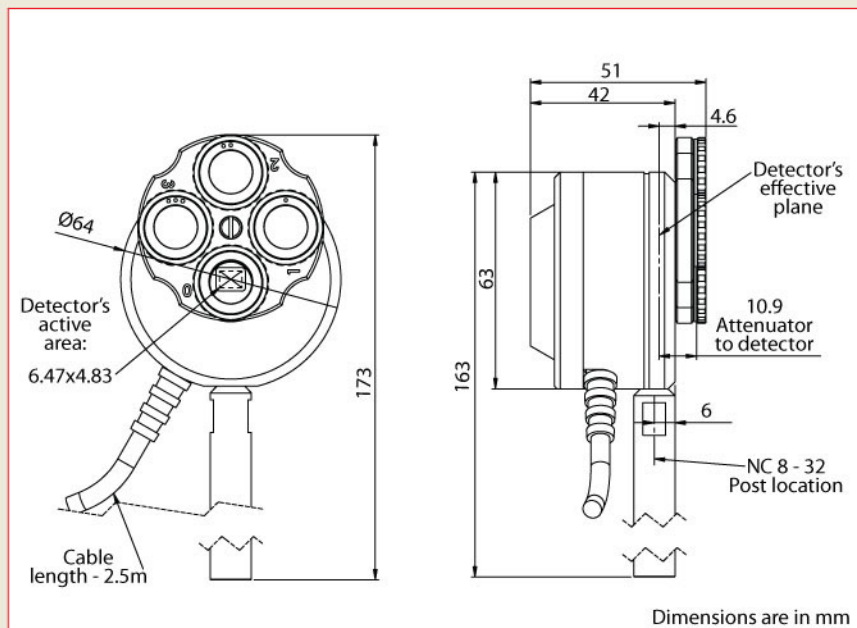

## CCD Head Specifications

<b>Camera type:</b>	Monochrome interline transfer CCD 1/2" format
<b>Pixel size:</b>	8.6µm(H)X8.3µm(V)
<b>Sensor active area:</b>	6.47mmX4.83mm
<b>weight:</b>	320 gr. with cable
<b>Power consumption:</b>	2.6 Watts through USB2.0 port
<b>Accessories included:</b>	Equipped with a built-in filter wheel, with 3xNG 1.6mm thick Schott colored filters, cap, mounting post



## General Specifications

<b>PC interface:</b>	USB2.0 Attachment, 1.8m long
<b>RS232 / TCP-IP:</b>	Data out
<b>Operating temp:</b>	-10°C to 50°C
<b>Storage temp:</b>	-40°C - 60°C
<b>CE compliance</b>	



## Ordering Information

The system comes with a camera, a post, a built-in filter wheel with a set of 3xNG Schott colored filters (NG4, NG9, NG10) in housing, a USB2.0 Attachment, software and user manual on CD disk / DiskOnKey, carrying case.

	spectral range
<b>BeamOn VIS-NIR:</b>	350-1310nm
<b>BeamOn UV-NIR:</b>	190-1310nm
<b>BeamOn IR1550:</b>	1550nm±50nm
<b>NG Filter (4/9/10):</b>	1.6mm thick Schott colored filter in mount, select type:4/9/10
<b>BeamOn-Sampler:</b>	Attachment for high power lasers attenuation (up to 20W)



## Host Computer Requirements

Pentium IV, Dual-Core, 2GHz, 512MB RAM, 64 MB 16 bit color VGA card, resolution 1024x768, CD ROM any type, High Speed USB2.0 port, OS Win / 2000 / XP / Vista / 7 32bit / 64 bit / 8.



## System Performance with Software

### System Response

VIS - NIR	350-1310nm	(**) Model IR1550 is based on the standard CCD for VIS - NIR which is coated with a conversion coating, enabling capture of signals at 1550nm +/-50nm.
UV - NIR	190-1310nm(*)	
IR1550	1550nm(**)	

(\*) Windowless CCD

<b>Max frame rate:</b>	25Hz
<b>Image resolution:</b>	720X576
<b>Shutter speed:</b>	1/50 to 1/100000sec, 9 steps
<b>Gain control:</b>	6dB to 60dB, 16 steps
<b>Null:</b>	In CW mode Null function is available to automatically subtract background
<b>Optical dynamic range:</b>	up to 1X10 <sup>11</sup> using all filters and software controlled electronic shutter and gain
<b>Damage threshold:</b>	50W/cm <sup>2</sup> with filters
<b>Sensitivity:</b>	~0.5nW/cm <sup>2</sup> at 633 nm (VIS-NIR, UV-NIR) ~1.5µW/mm <sup>2</sup> at 1310 nm (VIS-NIR, UV-NIR) ~5µW/mm <sup>2</sup> at 1550 nm (model IR 1550)
<b>Saturation:</b>	~1mW/cm <sup>2</sup> , no filters (VIS-NIR, UV-NIR) ~5mW/cm <sup>2</sup> no filters (model IR 1550)

<b>Operation with pulsed lasers:</b>	Ability to capture and replay images from slowly pulsing lasers (1-100Hz) while filtering out frames with no laser pulse. Provision for displaying single shot pulses.
<b>Triggering:</b>	In pulsed mode set threshold by slide bar to display frames with captured pulses

<b>Max frequency for single pulse display:</b>	10KHz
--	-------



## DUMA OPTRONICS LTD.

1st Hazait St., P.O.Box 3370 Nesher 20306, Israel Tel:972-4-8200577 Fax: 972-4-8204190  
Website: <http://www.duma.co.il> E-mail: [sales@duma.co.il](mailto:sales@duma.co.il)