

specification



**MSE series**  
colorimeter





## Contents

1	MSE series .....	3
2	Highlights.....	3
3	MSE general specifications .....	4
4	Typical spectral sensitivity of MSE series .....	4
5	MSE series overview.....	5
6	MSE 10mm specifications .....	6
7	MSE fiber with 5 mm specifications .....	7
8	MSE 10mm dimensions .....	8
9	MSE fiber dimensions .....	9
10	MSE+ 10mm specifications.....	10
11	MSE+ 20mm specifications.....	11
12	MSE+ fiber with 5mm specifications .....	12
13	MSE+ fiber with 20mm specifications .....	13
14	MSE+ 10mm dimensions .....	14
15	MSE+ 20mm dimensions .....	15
16	MSE+ fiber dimensions .....	15



## 1 MSE series: high speed and accurate colorimeter for display measurements

The MSE Series colorimeter offers a unique combination of high speed and accurate colour measurement capabilities packed in a robust package. The MSE colorimeter is available in 10mm spot size and MSE+ with Wide Dynamic Range in 10mm and 20mm spot size. In addition, M8 fiber connector versions are available of both MSE and MSE+.

Thanks to its supreme quality, robustness of both hardware and software and its compact size, the MSE is the ultimate choice for in-line colour measurement applications. Thanks to its build-in mechanical shutter, dark measurements are carried out easily and accurately.

The MSE Series are predominantly found inline in display production facilities, their customers or the adjacent R&D departments to handle white point adjustment, uniformity, flicker, reaction time and general colour quality control.



## 2 Highlights

- Absolute colour measurement according to human eye (CIE1931)
- Colour measurement even at low luminance level
- Colour measurement in XYZ, Yxy, Yu'v'
- Other colour spaces available via a supplied colour library
- Fast colour measurement: 140 measurements/second at luminance level 200 cd/m<sup>2</sup>
- High speed luminance (Y) function: 22.000 luminance samples/second
- Mechanical shutter for accurate dark level measurement
- Trigger in and output for inline applications
- USB and RS232 communication interface
- USBMTC standard compliant
- Windows, Linux and MAC OSX compatible
- Directly supported in Labview, Labwindows, Visual Studio via VISA library



### 3 MSE general specifications

Interfaces	
USB 2.0	USBMTC compliant, SCPI command set, full speed device
RS 232	For PC and embedded purposes, using same command set as USB
Trigger in & out	5V compliant

Power ratings				
	Min voltage	Typical voltage	Max voltage	Max current
USB power no shutter used	4.75V	5.00V	5.25V	120mA
USB power Shutter used	4.75V	5.00V	5.25V	225mA

Measurement system	
Photo detector	Silicon photo diode using XYZ interference filter
Spectral response	Approximates CIE 1931 colour matching functions
Measurement parameters	XYZ, Yxy, Yuv, correlated color temperature (CCT), dominant wavelength DWL, Flicker, Response time
Size (HxWxD)	63 x 24 x 65 mm (without lens system)
Weight 20mm version	255 gram
Weight 10mm version	190 gram
Weight fiber version	170 gram (excluding accessories)
Mounting	12 M3 thread holes spread over four sides of MSE

### 4 Typical spectral sensitivity of MSE series

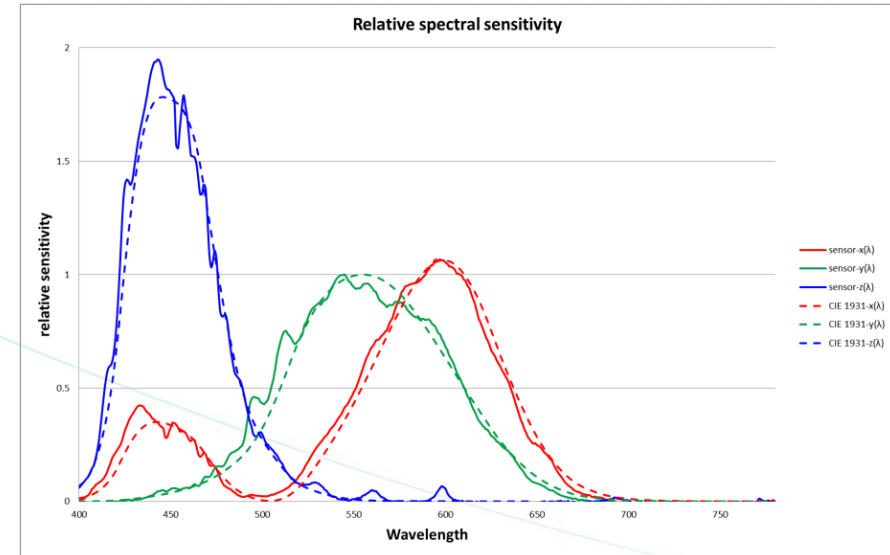

Fig 1 Spectral sensitivity of the MSE series colorimeter.



## 5 MSE series overview

Admesy currently offers the following MSE versions:

- MSE 10mm
- MSE F with fiber and optional lens
- MSE+ 10mm
- MSE+ 20mm
- MSE+ F with fiber and optional lens

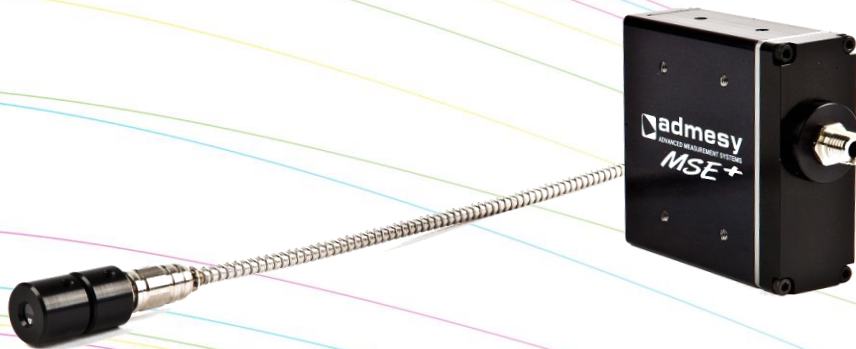



## 6 MSE 10mm specifications

Measurement system			
Optical system	Acceptance angle 5° (+/- 2.5)		
Measurement spot size	10mm at 50mm distance	12mm at 100mm distance	
Measurement speed	Luminance 22000samples / second Colour 7ms or higher, depending on luminance level 150cd/m <sup>2</sup> with DC level light at 50ms. PWM requires longer integration (multiple frames) Correct detected frequency of 1kHz		
Colorimeter specification			
Parameter	Range	Accuracy	Repeatability
Resolution	15 bit for X, Y and Z	>78dB without averaging	
Luminance (Y)	0.05cd/m <sup>2</sup> - 3000cd/m <sup>2</sup> integration time between 1ms and 5s	+/-4% of measured value Measured at white image of CCFL LCD display, Luminance of app. 150cd/m <sup>2</sup> x = 0.325 y = 0.355	Y +/-0.3% for Y at 0.1cd/m <sup>2</sup> <sup>1</sup> Y +/-0.15% for Y at 1cd/m <sup>2</sup> <sup>1</sup> Y +/-0.08% for Y at 5cd/m <sup>2</sup> <sup>1</sup> Y +/-0.06% for Y at 150cd/m <sup>2</sup> <sup>1</sup>
Chromaticity (x,y)		+/-0.001 after calibration Measured at white image of CCFL LCD display, Luminance ~ 150cd/m <sup>2</sup> x = 0.325 y = 0.355	x,y +/-0.003 for Y at 0.1cd/m <sup>2</sup> <sup>1</sup> x,y +/-0.001 for Y at 1cd/m <sup>2</sup> <sup>1</sup> x,y +/-0.0005 for Y at 5cd/m <sup>2</sup> <sup>1</sup> x,y +/-0.0002 for Y at 150cd/m <sup>2</sup> <sup>1</sup>
Measurement speed			1 sample/s for Y at 0.1cd/m <sup>2</sup> <sup>1</sup> 2-5 samples/s for Y at 1cd/m <sup>2</sup> <sup>1</sup> 5-10 samples/s for Y at 5cd/m <sup>2</sup> <sup>1</sup> 10-50 samples/s for Y at 150cd/m <sup>2</sup> <sup>1</sup>
CR measurement	>200000	+/-5% depending on lowest Y value	+/-5% depending on lowest Y value
Flicker (contrast method)	10cd/m <sup>2</sup> or higher	+/-2% flicker frequency 30Hz AC/DC 10% sine wave	+/-1%
Flicker (JEITA method)	10cd/m <sup>2</sup> or higher	+/-2dB flicker frequency 30Hz AC/DC 10% sine wave	+/-1dB
Operating temperature	10-35°C <sup>2</sup>		
Shutter lifetime	>1000000		
Shutter speed	250 – 300ms depending on temperature and lifetime		

<sup>1</sup> All measurements are performed 20 times on a CCFL LED display with sufficient signal noise ratio, value is based on 2 sigma. Sample speed depends on the measured sample. If the sample uses PWM, it will take longer.

<sup>2</sup> Operating temperature reaches from 0 to 40 degrees. Dark level compensation is optimized for operating in temperatures between 10 and 35 degrees. Other temperature ranges can be calibrated using the mechanical shutter if necessary.



## 7 MSE fiber with 5 mm specifications

Measurement system			
Optical system	Acceptance angle 5° (+/- 2.5)		
Measurement spot size	5.15mm at 30mm distance	5.18mm at 40mm distance	5.36mm at 50mm distance
Fiber	800µm fiber with metal jacket		
Measurement speed	Luminance 22000samples / second Colour 7ms or higher, depending on luminance level 150cd/m <sup>2</sup> with DC level light at 100ms. PWM requires longer integration (multiple frames)		
Colorimeter specification			
Parameter	Range	Accuracy	Repeatability
Resolution	15 bit for X, Y and Z	>78dB without averaging	
Luminance (Y)	0.1cd/m <sup>2</sup> - 5000cd/m <sup>2</sup> integration time between 100µs and 5s	+/-4% of measured value Measured at white image of CCFL LCD display, Luminance of app. 150cd/m <sup>2</sup> x = 0.325 y = 0.355	Y +/-1% for Y at 0.1cd/m <sup>2</sup> <sup>1</sup> Y +/-0.5% for Y at 1cd/m <sup>2</sup> <sup>1</sup> Y +/-0.1% for Y at 5cd/m <sup>2</sup> <sup>1</sup> Y +/-0.08% for Y at 150cd/m <sup>2</sup> <sup>1</sup>
Chromaticity (x,y)	Approximates CIE 1931 colour matching functions	+/-0.001 after calibration Measured at white image of CCFL LCD display, Luminance of app. 150cd/m <sup>2</sup> x = 0.325 y = 0.355	x,y +/-0.003 for Y at 0.1cd/m <sup>2</sup> <sup>1</sup> x,y +/-0.002 for Y at 1cd/m <sup>2</sup> <sup>1</sup> x,y +/-0.0008 for Y at 5cd/m <sup>2</sup> <sup>1</sup> x,y +/-0.0002 for Y at 150cd/m <sup>2</sup> <sup>1</sup>
Measurement speed			0.2 samples/s for Y at 0.1cd/m <sup>2</sup> <sup>1</sup> 1 sample/s for Y at 1cd/m <sup>2</sup> <sup>1</sup> 5 samples/s for Y at 5cd/m <sup>2</sup> <sup>1</sup> 10-20 samples/s for Y at 150cd/m <sup>2</sup> <sup>1</sup>
CR measurement	>200000	+/-5% depending on lowest Y value	+/-5% depending on lowest Y value
Flicker (contrast method)	20cd/m <sup>2</sup> or higher	+/-3% flicker frequency 30Hz AC/DC 10% sine wave	+/-2%
Flicker (JEITA method)	20cd/m <sup>2</sup> or higher	+/-3dB flicker frequency 30Hz AC/DC 10% sine wave	+/-2dB
Operating temperature	10-35°C <sup>2</sup>		
Shutter lifetime	>1000000		
Shutter speed	250 – 300 ms depending on temperature and lifetime		

<sup>1</sup> All measurements are performed 20 times on a CCFL LED display with sufficient signal noise ratio, value is based on 2 sigma. Sample speed depends on the measured sample. If the sample uses PWM, it will take longer.

<sup>2</sup> Operating temperature reaches from 0 to 40 degrees. Dark level compensation is optimized for operating in temperatures between 10 and 35 degrees. Other temperature ranges can be calibrated using the mechanical shutter if necessary.



## 8 MSE 10mm dimensions

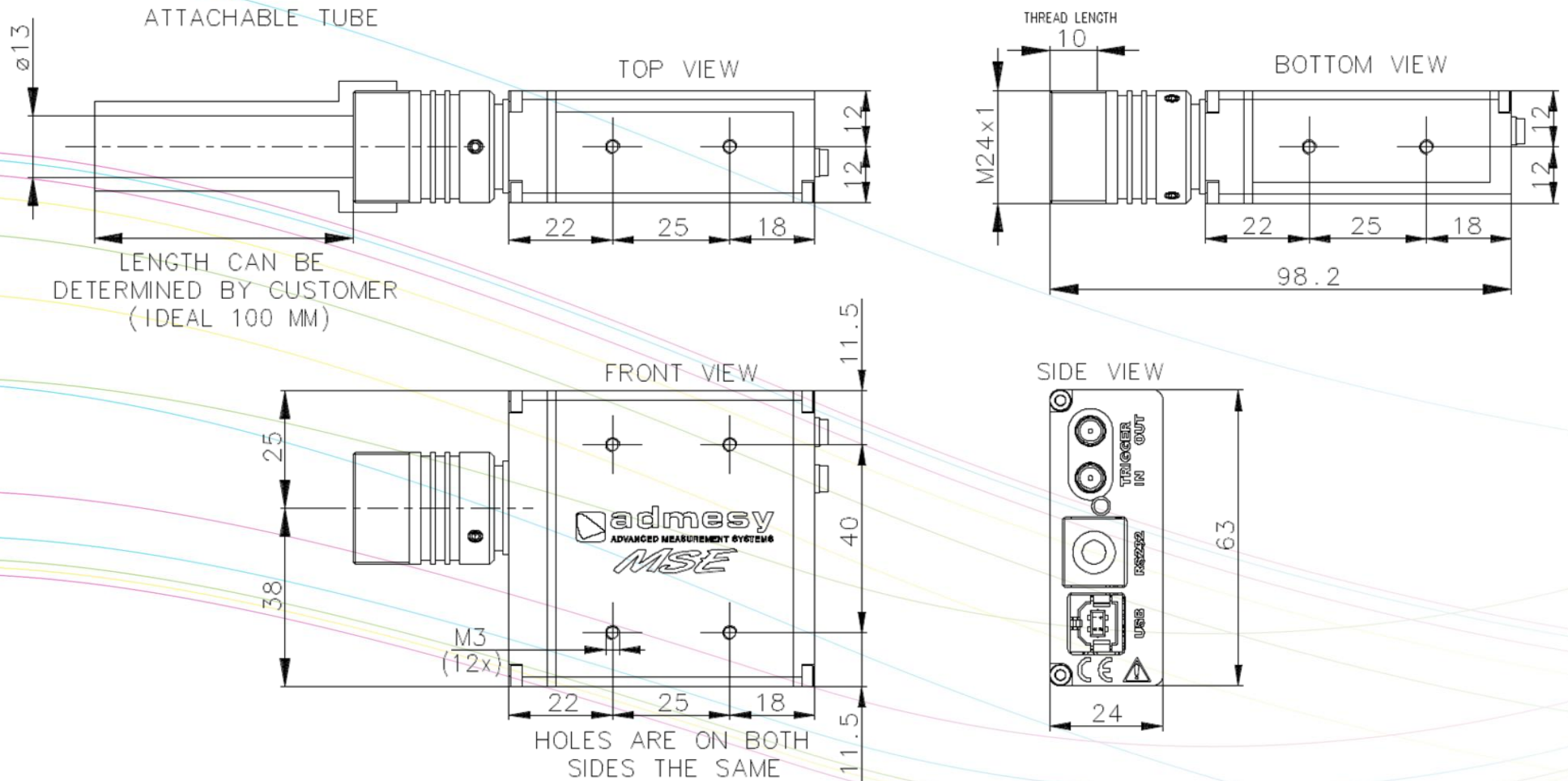





## 9 MSE fiber dimensions

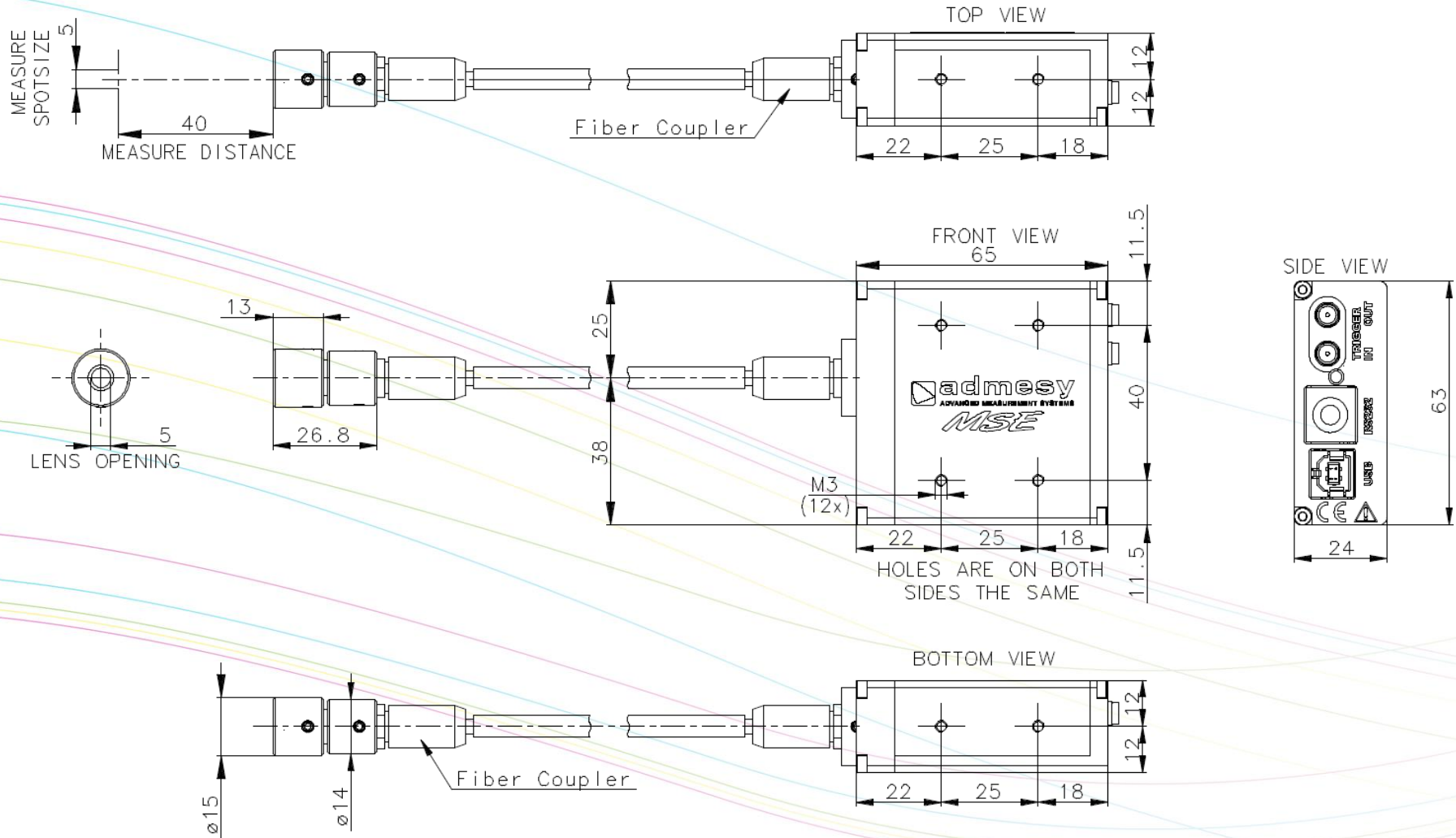



## 10 MSE+ 10mm specifications

Measurement system			
Optical system	Acceptance angle 5° (+/- 2.5)		
Measurement spot size	10mm at 50mm distance	12mm at 100mm distance	
Measurement speed	Luminance 22000samples / second Colour 7ms or higher, depending on luminance level 150cd/m <sup>2</sup> with DC level light at 50ms. PWM requires longer integration (multiple frames) Correct detected frequency of 1kHz		
Colorimeter specification			
Parameter	Range	Accuracy	Repeatability
Resolution	15 bit for X, Y and Z	>78dB without averaging	
Luminance (Y)	0.05cd/m <sup>2</sup> - 30000cd/m <sup>2</sup> integration time between 1ms and 5s	+/-4% of measured value Measured at white image of CCFL LCD display, Luminance of app. 150cd/m <sup>2</sup> x = 0.325 y = 0.355	Y +/-0.3% for Y at 0.1cd/m <sup>2</sup> <sup>1</sup> Y +/-0.15% for Y at 1cd/m <sup>2</sup> <sup>1</sup> Y +/-0.08% for Y at 5cd/m <sup>2</sup> <sup>1</sup> Y +/-0.06% for Y at 150cd/m <sup>2</sup> <sup>1</sup>
Chromaticity (x,y)		+/-0.001 after calibration Measured at white image of CCFL LCD display, Luminance of app. 150cd/m <sup>2</sup> x = 0.325 y = 0.355	x,y +/-0.003 for Y at 0.1cd/m <sup>2</sup> <sup>1</sup> x,y +/-0.001 for Y at 1cd/m <sup>2</sup> <sup>1</sup> x,y +/-0.0005 for Y at 5cd/m <sup>2</sup> <sup>1</sup> x,y +/-0.0002 for Y at 150cd/m <sup>2</sup> <sup>1</sup>
Measurement speed			1 sample/s for Y at 0.1cd/m <sup>2</sup> <sup>1</sup> 2-5 samples/s for Y at 1cd/m <sup>2</sup> <sup>1</sup> 5-10 samples/s for Y at 5cd/m <sup>2</sup> <sup>1</sup> 10-50 samples/s for Y at 150cd/m <sup>2</sup> <sup>1</sup>
CR measurement	>200000	+/-5% depending on lowest Y value	+/-5% depending on lowest Y value
Flicker (contrast method)	10cd/m <sup>2</sup> or higher	+/-2% flicker frequency 30Hz AC/DC 10% sine wave	+/-1%
Flicker (JEITA method)	10cd/m <sup>2</sup> or higher	+/-2dB flicker frequency 30Hz AC/DC 10% sine wave	+/-1dB
Operating temperature	10-35°C <sup>2</sup>		
Shutter lifetime	>1000000		
Shutter speed	250 – 300 ms depending on temperature and lifetime		

<sup>1</sup> All measurements are performed 20 times on a CCFL LCD screen with sufficient signal noise ratio, value is based on 2 sigma. Sample speed depends on the measured sample as well : If the sample uses PWM it will take longer so use the lower rated values.

<sup>2</sup> Operating temperature reaches from 0- 40 degrees, but dark level compensation works best between 10-35 degrees. Other temperature ranges can be calibrated using the mechanical shutter if necessary.



## 11 MSE+ 20mm specifications

Measurement system			
Optical system	Acceptance angle 5° (+/- 2.5)		
Measurement spot size	18.4mm at 50mm distance	19mm at 75mm distance	20mm at 100mm distance
	21.4mm at 150mm distance	23.4mm at 200mm distance	
Measurement speed	Luminance 22000samples / second Colour 1ms or higher, depending on luminance level 150cd/m <sup>2</sup> with DC level light at 30ms 0.3cd/m <sup>2</sup> with DC level light at 0.2s PWM mode not supported		
Colorimeter specification			
Parameter	Range	Accuracy	Repeatability
Resolution	15 bit for X, Y and Z	>78dB without averaging	
Luminance (Y)	0.008cd/m <sup>2</sup> - 15000cd/m <sup>2</sup> integration time between 1ms and 5s	+/-4% of measured value Measured at white image of CCFL LCD display, Luminance of app. 150cd/m <sup>2</sup> x = 0.325 y = 0.355	Y +/-0.3% for Y at 0.1cd/m <sup>2</sup> <sup>1</sup> Y +/-0.1% for Y at 1cd/m <sup>2</sup> <sup>1</sup> Y +/-0.05% for Y at 5cd/m <sup>2</sup> <sup>1</sup> Y +/-0.03% for Y at 150cd/m <sup>2</sup> <sup>1</sup>
Chromaticity (x,y)	Approximates CIE 1931 colour matching functions	+/-0.001 after calibration Measured at white image of CCFL LCD display, Luminance of app. 150cd/m <sup>2</sup> x = 0.325 y = 0.355	x,y +/-0.002 for Y at 0.1cd/m <sup>2</sup> <sup>1</sup> x,y +/-0.001 for Y at 1cd/m <sup>2</sup> <sup>1</sup> x,y +/-0.0005 for Y at 5cd/m <sup>2</sup> <sup>1</sup> x,y +/-0.0002 for Y at 150cd/m <sup>2</sup> <sup>1</sup>
Measurement speed			1-2 samples/s for Y at 0.1cd/m <sup>2</sup> <sup>1</sup> 2-5 samples/s for Y at 1cd/m <sup>2</sup> <sup>1</sup> 5-10 samples/s for Y at 5cd/m <sup>2</sup> <sup>1</sup> 20-100 samples/s for Y at 150cd/m <sup>2</sup> <sup>1</sup>
CR measurement	>200000	+/-5% depending on lowest Y value	+/-5% depending on lowest Y value
Flicker (contrast method)	10cd/m <sup>2</sup> or higher	+/-2% flicker frequency 30Hz AC/DC 10% sine wave	+/-1%
Flicker (JEITA method)	10cd/m <sup>2</sup> or higher	+/-2dB flicker frequency 30Hz AC/DC 10% sine wave	+/-1dB
Operating temperature	10-35°C <sup>2</sup>		
Shutter lifetime	>1000000		
Shutter speed	250 – 300 ms depending on temperature and lifetime		

<sup>1</sup> All measurements are performed 20 times on a CCFL LCD screen with sufficient signal noise ratio, value is based on 2 sigma. Luminance and chromaticity values are based on best performance possible, while measurement speed is determined by Admesy with a signal noise ratio which is still acceptable according Admesy. Sample speed depends on the measured sample as well: If the sample uses PWM it will take longer so use the lower rated values. Detailed measurement data is available upon request

<sup>2</sup> Operating temperature reaches from 0- 40 degrees, but dark level compensation works best between 10-35 degrees. Other temperature ranges can be calibrated using the mechanical shutter if necessary.

General remark: All values are determined as realistic as possible and can slightly differ from device to device.



## 12 MSE+ fiber with 5mm specifications

Measurement system			
Optical system	Acceptance angle 5° (+/- 2.5)		
Measurement spot size	5.15mm at 30mm distance	5.18mm at 40mm distance (optimal distance)	5.36mm at 50mm distance
Fiber	800µm fiber with metal jacket		
Measurement speed	Luminance 22.000samples / second Colour 7ms or higher, depending on luminance level 150cd/m <sup>2</sup> with DC level light at 100ms. PWM requires longer integration (multiple frames)		
Colorimeter specification			
Parameter	Range	Accuracy	Repeatability
Resolution	15 bit for X, Y and Z	>78dB without	
Luminance (Y)	0.1cd/m <sup>2</sup> - 60000cd/m <sup>2</sup> integration time between 100µs and 5s	+/-4% of measured value Measured at white image of CCFL LCD display, Luminance of app. 150cd/m <sup>2</sup> x = 0.325 y = 0.355	Y +/-1% for Y at 0.1cd/m <sup>2</sup> <sup>1</sup> Y +/-0.5% for Y at 1cd/m <sup>2</sup> <sup>1</sup> Y +/-0.1% for Y at 5cd/m <sup>2</sup> <sup>1</sup> Y +/-0.08% for Y at 150cd/m <sup>2</sup> <sup>1</sup>
Chromaticity (x,y)	Approximates CIE 1931 colour matching functions	+/-0.001 after calibration Measured at white image of CCFL LCD display, Luminance of app. 150cd/m <sup>2</sup> x = 0.325 y = 0.355	x,y +/-0.003 for Y at 0.1cd/m <sup>2</sup> <sup>1</sup> x,y +/-0.002 for Y at 1cd/m <sup>2</sup> <sup>1</sup> x,y +/-0.0008 for Y at 5cd/m <sup>2</sup> <sup>1</sup> x,y +/-0.0002 for Y at 150cd/m <sup>2</sup> <sup>1</sup>
Measurement speed			0.2 samples/s for Y at 0.1cd/m <sup>2</sup> <sup>1</sup> 1 sample/s for Y at 1cd/m <sup>2</sup> <sup>1</sup> 5 samples/s for Y at 5cd/m <sup>2</sup> <sup>1</sup> 10-20 samples/s for Y at 150cd/m <sup>2</sup> <sup>1</sup>
CR measurement	>200000	+/-5% depending on lowest Y value	+/-5% depending on lowest Y value
Flicker (contrast method)	20cd/m <sup>2</sup> or higher	+/-3% flicker frequency 30Hz AC/DC 10% sine wave	+/-2%
Flicker (JEITA method)	20cd/m <sup>2</sup> or higher	+/-3dB flicker frequency 30Hz AC/DC 10% sine wave	+/-2dB
Operating temperature	10-35°C <sup>2</sup>		
Shutter lifetime	>1000000		
Shutter speed	250 – 300 ms depending on temperature and lifetime		

<sup>1</sup> All measurements are performed 20 times on a CCFL LCD screen with sufficient signal noise ratio, value is based on 2 sigma. Sample speed depends on the measured sample as well : If the sample uses PWM it will take longer so use the lower rated values.

<sup>2</sup> Operating temperature reaches from 0- 40degrees, but dark level compensation works best between 10-35 degrees.



### 13 MSE+ fiber with 20mm specifications

Measurement system			
Optical system	Acceptance angle 0.6° (+/- 0.3)		
Measurement spot size	20.5mm at 50mm distance	21mm at 100mm distance	21.5mm at 150mm distance
Fiber	800µm fiber with metal jacket		
Measurement speed	Luminance 22.000samples / second Colour 7ms or higher, depending on luminance level 150cd/m <sup>2</sup> with DC level light at 100ms. PWM requires longer integration (multiple frames)		
Colorimeter specification			
Parameter	Range	Accuracy	Repeatability
Resolution	15 bit for X, Y and Z	>78dB without	
Luminance (Y)	0.1cd/m <sup>2</sup> - 60000cd/m <sup>2</sup> integration time between 100µs and 5s	+/-4% of measured value Measured at white image of CCFL LCD display, Luminance of app. 150cd/m <sup>2</sup> x = 0.325 y = 0.355	Y +/-1.5% for Y at 0.1cd/m <sup>2</sup> <sup>1</sup> Y +/-0.7% for Y at 1cd/m <sup>2</sup> <sup>1</sup> Y +/-0.1% for Y at 5cd/m <sup>2</sup> <sup>1</sup> Y +/-0.08% for Y at 150cd/m <sup>2</sup> <sup>1</sup>
Chromaticity (x,y)	Approximates CIE 1931 colour matching functions	+0.001 after calibration Measured at white image of CCFL LCD display, Luminance of app. 150cd/m <sup>2</sup> x = 0.325 y = 0.355	x,y +/-0.004 for Y at 0.1cd/m <sup>2</sup> <sup>1</sup> x,y +/-0.003 for Y at 1cd/m <sup>2</sup> <sup>1</sup> x,y +/-0.001 for Y at 5cd/m <sup>2</sup> <sup>1</sup> x,y +/-0.0002 for Y at 150cd/m <sup>2</sup> <sup>1</sup>
Measurement speed			0.2 samples/s for Y at 0.1cd/m <sup>2</sup> <sup>1</sup> 1 sample/s for Y at 1cd/m <sup>2</sup> <sup>1</sup> 5 samples/s for Y at 5cd/m <sup>2</sup> <sup>1</sup> 10-20 samples/s for Y at 150cd/m <sup>2</sup> <sup>1</sup>
CR measurement	>200000	+/-5% depending on lowest Y value	+/-5% depending on lowest Y value
Flicker (contrast method)	20cd/m <sup>2</sup> or higher	+/-3% flicker frequency 30Hz AC/DC 10% sine wave	+/-2%
Flicker (JEITA method)	20cd/m <sup>2</sup> or higher	+/-3dB flicker frequency 30Hz AC/DC 10% sine wave	+/-2dB
Operating temperature	10-35°C <sup>2</sup>		
Shutter lifetime	>1000000		
Shutter speed	250 – 300 ms depending on temperature and lifetime		

<sup>1</sup> All measurements are performed 20 times on a CCFL LCD screen with sufficient signal noise ratio, value is based on 2 sigma. Sample speed depends on the measured sample as well : If the sample uses PWM it will take longer so use the lower rated values.

<sup>2</sup> Operating temperature reaches from 0- 40degrees, but dark level compensation works best between 10-35 degrees.



## 14 MSE+ 10mm dimensions

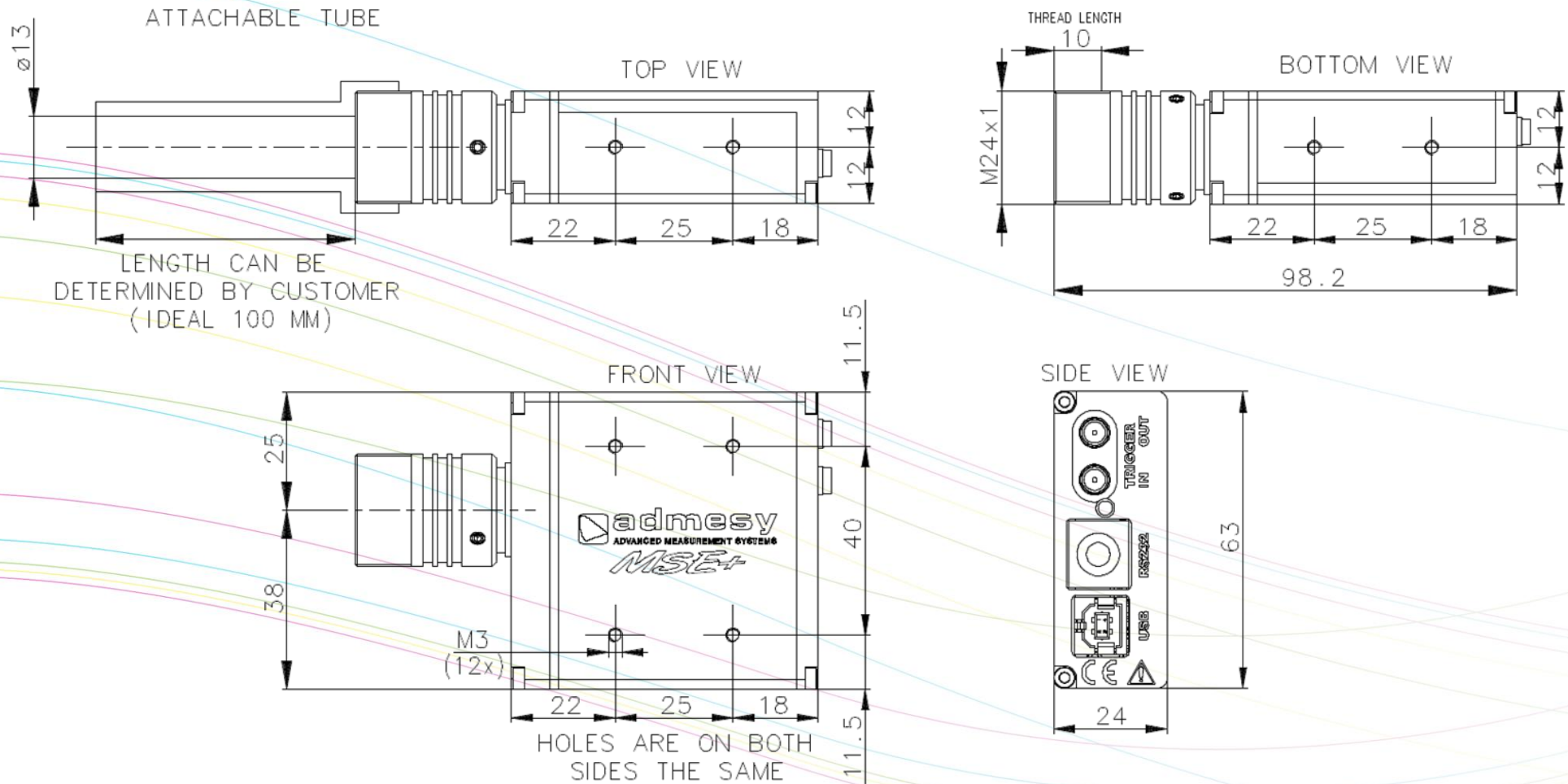



## 15 MSE+ 20mm dimensions

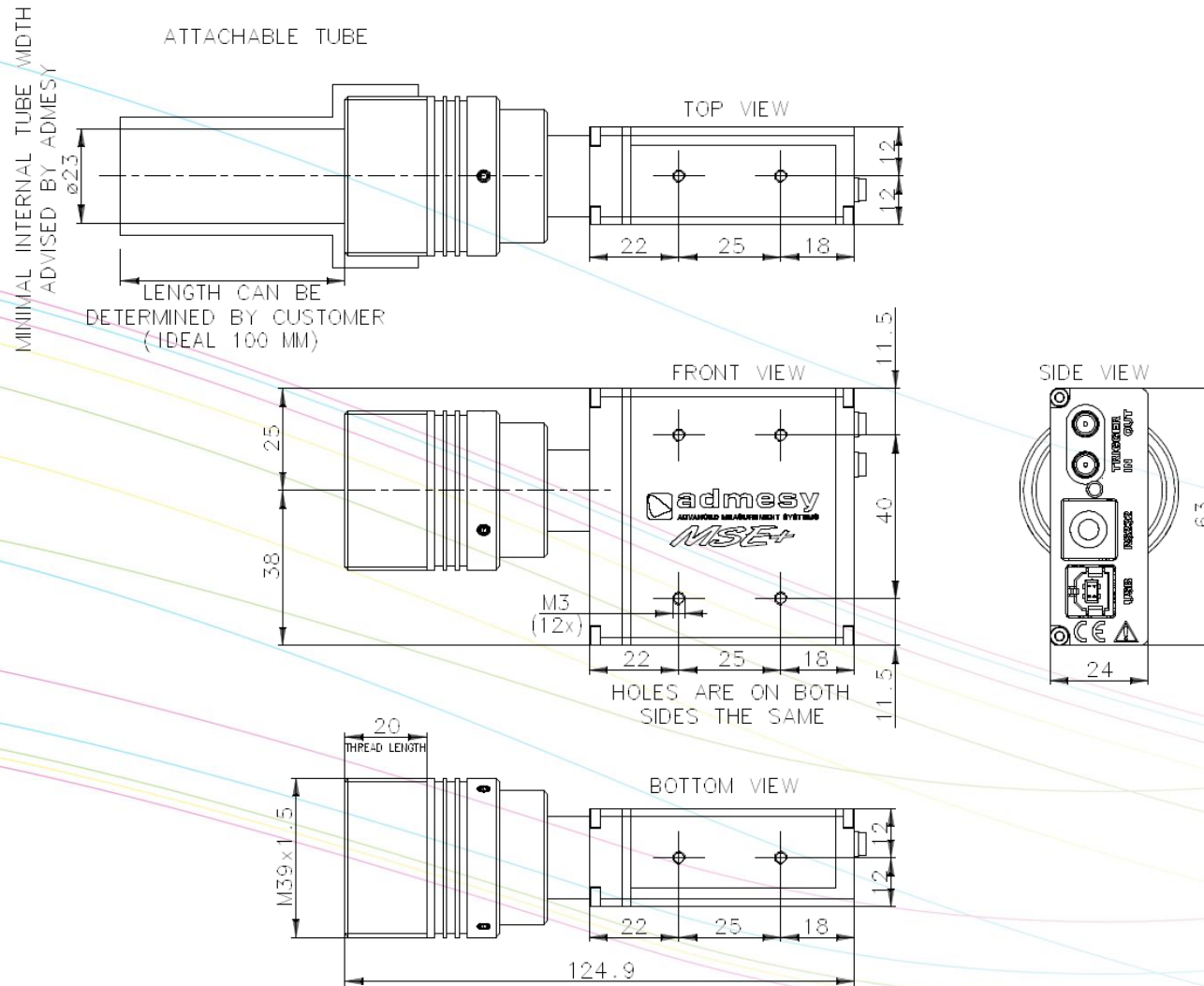



## 16 MSE+ fiber dimensions

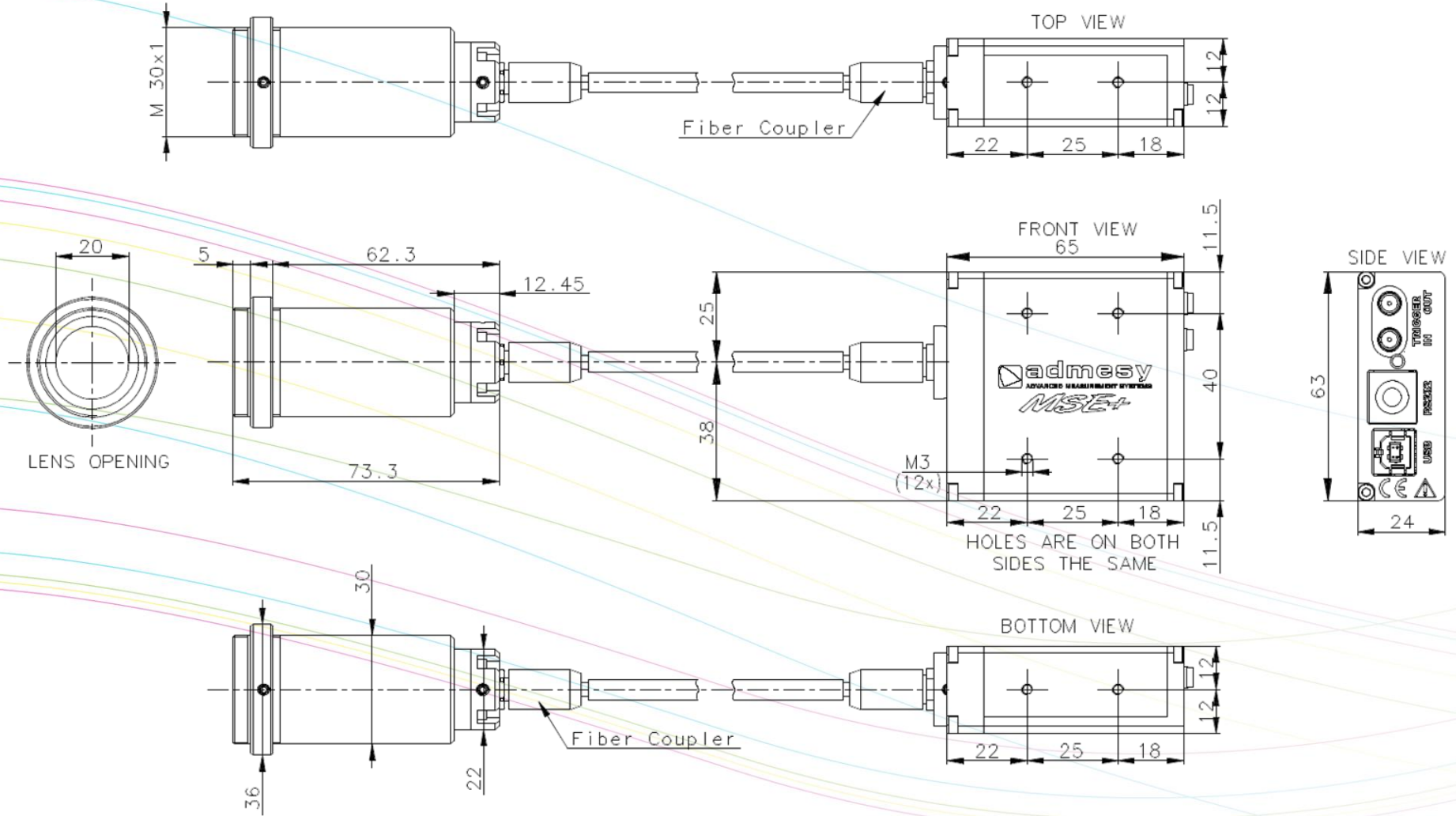





Admesy B.V.  
Sleestraat 3  
6014 CA Ittervoort  
The Netherlands

T +31 (0)475 600 232  
F +31 (0)475 600 316

[www.admesy.com](http://www.admesy.com)  
[info@admesy.com](mailto:info@admesy.com)

The material in this document is subject to change. No rights can be derived from the content of this document. All rights reserved. No part of this document may be reproduced, stored in a database or retrieval system, or published in any form or way, electronically, mechanically, by print, photo print, microfilm or any other means without prior written permission from the publisher.

Version 1.0.13 04/2017